

DESCRIPTION





Luminaire with direct luminous flux distribution, opal polycarbonate diffuser and aluminium housing.

STANDARDS



EN 60598-1:2015, EN 60598-2-1:1989, EN 62031:2008, EN 62471-5:2008

Refer to EC Declaration for specific standards.

FEATURES

-  Pendant
-  LED
- IP40** General
- IK07** Mechanical Resistance
-  850°C Glow Wire Test
- CE** 2014/30/EU, 2014/35/EU
-  2 Kg
-  5-year guarantee

ELECTRICAL SYSTEM

- U_{IN}** 24V DC
- 23.0W** Energy Consumption
-  Power Supply Not Included
-  Class III

LUMINOUS EFFICACY

- 2472 lm** Total Luminous Flux
- 107 lm/w** Luminous Efficacy
- 115.88 cd/klm** MAX
- 100.00%** LOR

LED FEATURES

- 3000K** Colour Temperature
- 134 Lm/W @TC=65°C** LED Efficacy
- 3** MacAdam Ellipse
- 50.000H @TC=55°C** Lifetime
- L80** Luminous Flux Maintenance
- F10** LED Degradation/Mortality
- 120°** Light Distribution Angle

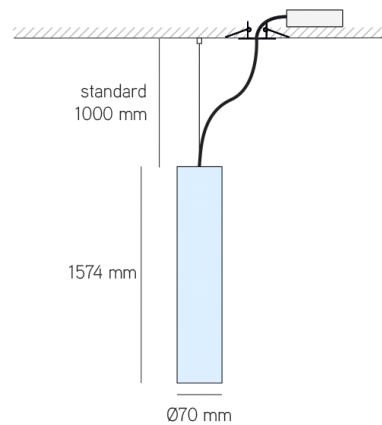
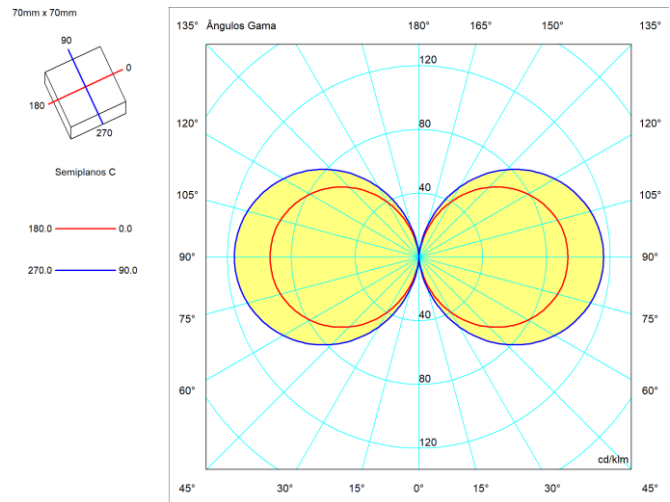

COMPONENTS

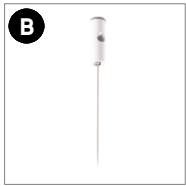

35.42.001.01.77
1xSuspension
Cable/Cabo suspensão
White 1000mm

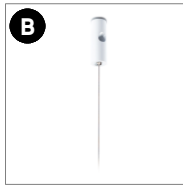

35.42.001.01.78
1xSuspension
Cable/Cabo suspensão
White 3000mm

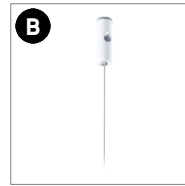

35.42.001.01.79
1xSuspension
Cable/Cabo suspensão
White 5000mm



35.49.001.08.31
Recessed ceiling cup
White Tupoli ON/OFF
(1m) Ø80x2mm

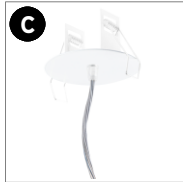

35.49.002.08.63
Recessed ceiling cup
White Tupoli ON/OFF
(3m) Ø80x2mm

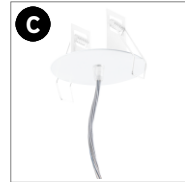

35.49.002.08.71
Recessed ceiling cup
White Tupoli ON/OFF
(5m) Ø80x2mm



35.00.003.01.73
Power Supply Constant
Voltage 24Vdc 12 - 86W
IP20



35.00.003.01.74
Power Supply Constant
Voltage 24Vdc 6 - 49W
IP20



35.00.003.01.75
Power Supply Constant
Voltage 24Vdc 4 - 32W
IP20



35.00.003.01.76
Power Supply Constant
Voltage 24Vdc 12 - 90W
IP20 DALI



35.00.003.01.77
Power Supply Constant
Voltage 24Vdc 18 -
135W IP20 DALI

